

Resolution No. **2024-02-22-0302**

STOCKTON PLANNING COMMISSION

RESOLUTION APPROVING A SECOND ONE-YEAR TIME EXTENSION FOR AN APPROVED VESTING TENTATIVE MAP FOR THE TRA VIGNE WEST PROJECT SITE (APPLICATION NO. P22-0345)

On June 23, 2020, the City Council approved the Tra Vigne Mixed-Use Development Project (P16-0052) which included a Vesting Tentative Map (VTM) ("Approved Map") for a project known as "Tra Vigne West". The Tra Vigne Development Project included a General Plan Amendment, Annexation, Rezoning, Vesting Tentative Maps, and Environmental Impact Report application to subdivide a 205-acre site into 655 lots for single-family residential units, 340 multi-family residential units, and commercial development. Additionally, the project would establish a 14.7-acre K-8 school site to be developed by the Lodi Unified School District. The project site is located on the southeast corner of Eight Mile Road and West Road; and

On February 17, 2021, the Planning Commission approval became effective upon the recordation of the LAFCo certificate of completion which officially annexes the property into the City; and

The original map is set to expire two (2) years after the date of the LAFCo certificate, which is February 17, 2023; and

On January 26, 2023, the Planning Commission approved a one-year time extension for the Tra Vigne West Tentative Map extending the expiration to February 17, 2024; and

On December 11, 2023, the applicant submitted an application for a second one-year time extension; and

On February 22, 2024, the Planning Commission held a meeting, in accordance with Stockton Municipal Code (SMC) Section 16.88.050(C), to consider the time extension request, at which time all interested parties had the opportunity to be heard, now; therefore,

BE IT RESOLVED BY THE PLANNING COMMISSION OF THE CITY OF STOCKTON AS FOLLOWS:

1. The foregoing recitals are true and correct and incorporated by reference.
2. Based upon its review of the entire record herein, the Planning

Commission makes the following findings:

SMC section 16.188.100 (Tentative Map Processing, Post Approval Procedures)

- a. There have been no changes to the provisions of the General Plan or any applicable specific plan, precise road plan, or master development plan that would cause the Tentative Map to be inconsistent with the General Plan, because the site is still Low-Density, Residential, High-Density Residential, and Commercial designations on the 2040 General Plan Land Use. (SMC 16.188.100(C)(a)(i))
- b. There have been no changes to applicable provisions of the Development Code that would cause the Vesting Tentative Map to be inconsistent with the Development Code. The residential parcels contained in the Tentative Map remain consistent with the lot standards at SMC section 16.24.200, Table 2-3 (Zoning District Development Standards). (SMC 16.188.100(C)(a)(ii))
- c. There have been no changes in the character of the site or its surroundings that affect how the policies of the General Plan or other standards of this Development Code apply to the project. When the Vesting Tentative Map was approved, the site was bounded by vacant lands to the south, east and west, and lands within the County of San Joaquin to the North. These land uses remain unchanged. Approval of the Vesting Tentative Map extension will facilitate residential and commercial development that is consistent with the surrounding character. (SMC 16.188.100(C)(a)(iii))
- d. There have been no changes to the capacity of community resources, including roads, schools, sewage treatment or disposal facilities, or water supply, so that there is no longer sufficient remaining capacity to serve the project. Upon the review of the City's most recently adopted Sanitary Collection/Treatment Master Plan, Water system Master Plan and the Public Works Design Standards, all required infrastructure and public facilities, water supply, sewage treatment or disposal facilities as well as public streets have sufficient capacities to serve the project site. (SMC 16.188.100(C)(a)(iv))

SMC section 16.90 (Floodplain Management Findings)

- e. In accordance with SMC 16.90.020(A)(2), the proposed development shall comply with the 200-year flood requirements under Senate Bill (SB) 5. The State legislation requires that the property be protected to the urban level of flood protection in urban and urbanizing areas. Any structures within the 200-year flood depths would be required to be reduced to less than three feet and have an urban level of flood

protection.

California Environmental Quality Act

- f. The environmental consequences of this Tentative Map have been analyzed in accordance with the provisions of Section 15070 of the State California Quality Act (CEQA) Guidelines, the project shall be subject to all applicable mitigation measures identified in the city-adopted Environmental Impact Report (SCH #2016022061; Tra Vigne Development Project EIR) and the "Final Mitigation Monitoring and Reporting Program" for the Project. All mitigation measures for the approved Vesting Tentative Map remain applicable. No further environmental review is required to approve the requested time extension.

Planning Commission Action

Based on its review of the entire record herein, including the February 22, 2024, Planning Commission staff report, all supporting, referenced, and incorporated documents, and all comments received, the Planning Commission hereby approves a request for a one-year time extension for the approved vesting tentative map subject to the following conditions of approval:

Conditions of Approval

- 1. With this approval, the subject map, attached as Exhibit 1 and incorporated herein by reference, shall expire on February 17, 2025.
- 2. Comply with all applicable Federal, State, County and City codes, regulations, and adopted standards and pay all applicable fees.
- 3. Pursuant to section 15070 of the CEQA Guidelines, the project shall be subject to all applicable mitigation measures identified in the city-adopted Environmental Impact Report (SCH #2016022061; Tra Vigne Development Project EIR) and the "Final Mitigation Monitoring and Reporting Program" for the Project.
- 4. The previously approved Conditions of Approval in City Council Resolution 2020-06-23-1502-03 shall remain valid and in place for the development.

//
//
//
//
//
//
//
//

5. The owners, developers and/or successors-in-interest (ODS) shall be responsible for the City's legal and administrative costs associated with defending any legal challenge of the approvals for this project or its related environmental document.

PASSED, APPROVED, and ADOPTED February 22, 2024.

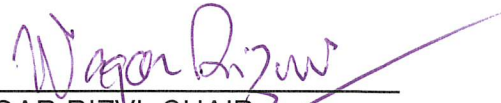

WAQAR RIZVI, CHAIR
City of Stockton Planning Commission

ATTEST:

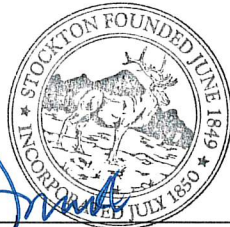

MICHAEL McDOWELL, SECRETARY
City of Stockton Planning Commission

TRA VIGNE WEST SUBDIVISION

VESTING TENTATIVE SUBDIVISION MAP

STOCKTON, CALIFORNIA

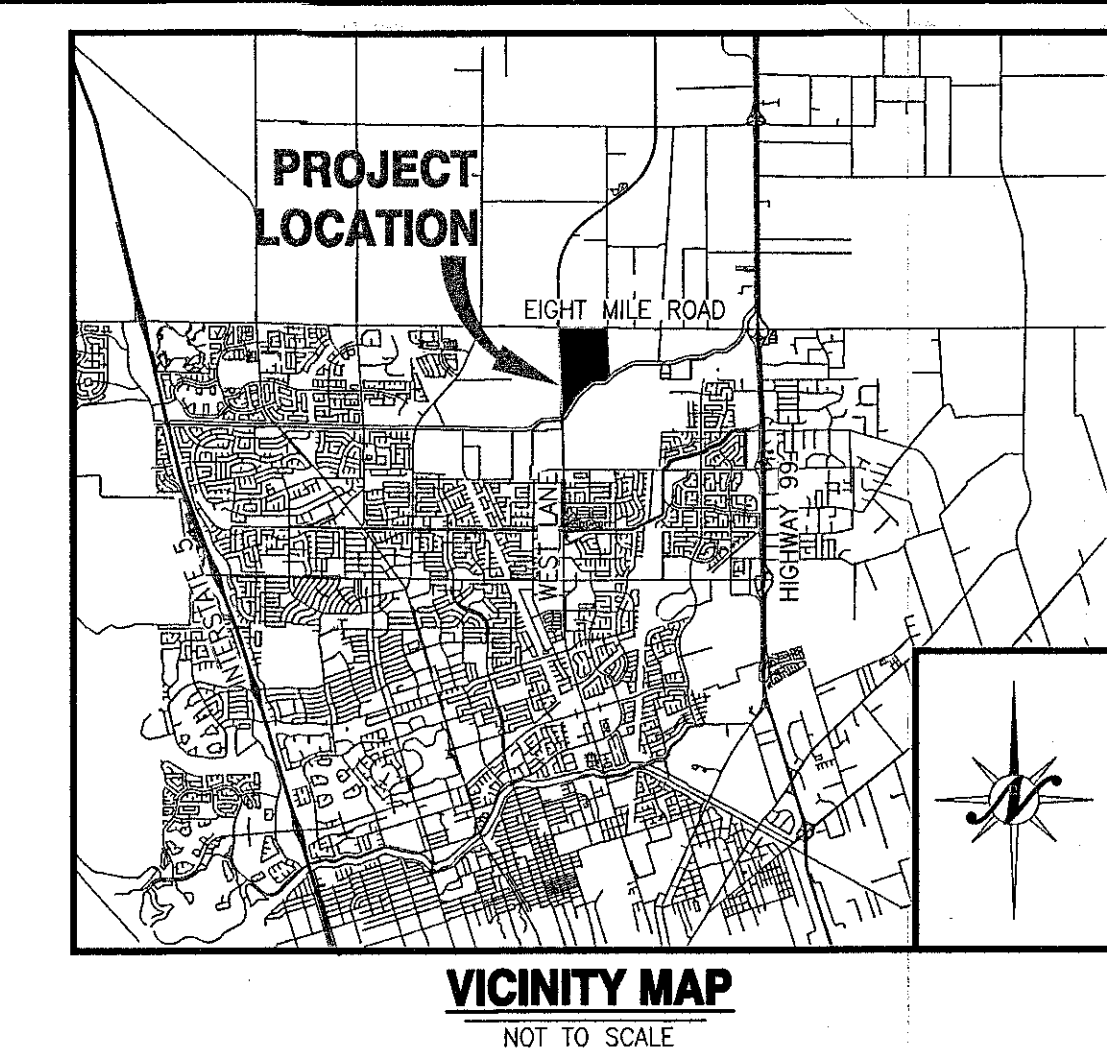

NO.	DATE	APPROVED	REVISIONS DESCRIPTIONS

GENERAL NOTES

- ALL IMPROVEMENTS SHALL BE CONSTRUCTED AS PER THE CITY OF STOCKTON STANDARD PLANS AND SPECIFICATIONS, EXCEPT AS NOTED.
- STORM DRAINAGE: BY POSITIVE SYSTEM DISCHARGE TO AN ON-SITE STORM DRAINAGE BASIN AND PUMP STATION. THE PROPOSED SYSTEM WILL DISCHARGE TO BEAR CREEK. ALL IMPROVEMENTS TO BE CONSTRUCTED TO THE CITY OF STOCKTON STANDARDS.
- SEWAGE DISPOSAL: BY CITY OF STOCKTON SEWER SYSTEM
- WATER SUPPLY: BY CITY OF STOCKTON WATER SYSTEM
- STREET LIGHTING SHALL BE INSTALLED AS PER THE CITY OF STOCKTON.
- ASSESSORS PARCEL Nos. 120-020-001 THRU 003, 120-020-017 THRU 020, 120-020-022, AND 023.
- LEGAL DESCRIPTION: ALL THAT CERTAIN REAL PROPERTY SITUATE IN THE UNINCORPORATED, COUNTY OF SAN JOAQUIN, STATE OF CALIFORNIA, BEING A PORTION OF SECTION 2, TOWNSHIP 2 NORTH, RANGE 6 EAST, MOUNT DIABLO BASE AND MERIDIAN
- PUBLIC UTILITIES ARE TO BE INSTALLED UNDER GROUND IN EASEMENTS.
- THE SUBDIVIDER HEREBY RESERVES THE RIGHT TO FILE "MULTIPLE SUBDIVISION MAPS" AS SET FORTH BY THE SUBDIVISION MAP ACT, ARTICLE 4, SECTION 66456.1, AND FILE PARCEL MAPS FOR REASON OF SALE. ALL PARCEL LINES SHALL CONFORM TO THIS TENTATIVE MAP.
- PURSUANT TO SECTION 66452.6 OF THE "SUBDIVISION MAP ACT", THE TERM OF THIS MAP MAY EXTEND 10 YEARS.
- PUBLIC UTILITY EASEMENTS WILL BE PROVIDED ALONG ALL STREET FRONTAGE.
- BUILDING SETBACKS WILL BE AS PER CITY OF STOCKTON STANDARDS.
- ALL EXISTING STRUCTURES AND TREES ARE TO BE REMOVED. SEPTIC TANKS, LEACH FIELDS, AND WELLS ON SITE WILL BE REMOVED OR ABANDONED AS PER CITY OF STOCKTON REQUIREMENTS.
- ALL OFF-SITE IMPROVEMENTS ALONG WEST LANE AND EIGHT MILE ROAD TO BE CONSTRUCTED IN ACCORDANCE WITH THE APPROVED PRECISE ROADWAY PLAN PREPARED BY NORTHSTAR ENGINEERING GROUP, INC. AND THE REQUIREMENTS SET FORTH IN THE APPROVED TRAFFIC STUDY.

LEGEND

	EXISTING	PROPOSED
BOUNDARY LINE	---	---
CENTERLINE	---	---
RIGHT-OF-WAY	---	---
PARCEL LINE	---	N/A
CURB AND GUTTER	N/A	---
EDGE OF PAVEMENT	---	---
STORM DRAIN (MAIN)	---(12"SD)---	---(12"SD)---
FORCE MAIN	---(8"FM)---	---(8"FM)---
DRAINAGE SWALE	---	---
STORM DRAIN MAINTENANCE HOLE	⊙	⊙
CURB INLET	⊙	⊙
DIRT ROAD	---	N/A
WATER (MAIN)	---(8"W)---	---(8"W)---
WATER VALVE	⊙	⊙
FIRE HYDRANT	⊙	⊙
SEWER MAINTENANCE HOLE	⊙	⊙
SEWER (MAIN)	---(12"SS)---	---(12"SS)---
OVER HEAD ELECTRICAL	---	N/A
GAS LINE	---	N/A
CENTERLINE ELEVATION	(68.34 CL)	68.34 CL
ORIGINAL GROUND	108.82	N/A
DIRECTION OF FLOW	003	003
CONTOURS	-32	-32
WALL (SEE LABEL FOR TYPE)	---	---
FENCE (CHAINLINK OR VINYL)	---	---
FENCE (WIRE OR HOGWIRE)	---	---
FENCE (WOOD OR WROUGHT IRON)	---	---
TREE OR SHRUB/TO BE REMOVED	⊗	N/A
IRRIGATION LINE	---	---
IRRIGATION VALVE	⊙	N/A
IRRIGATION PRESSURE MANHOLE/VENT	⊙	⊙
SIGN	⊙	⊙
SERVICE POLE	⊙	N/A

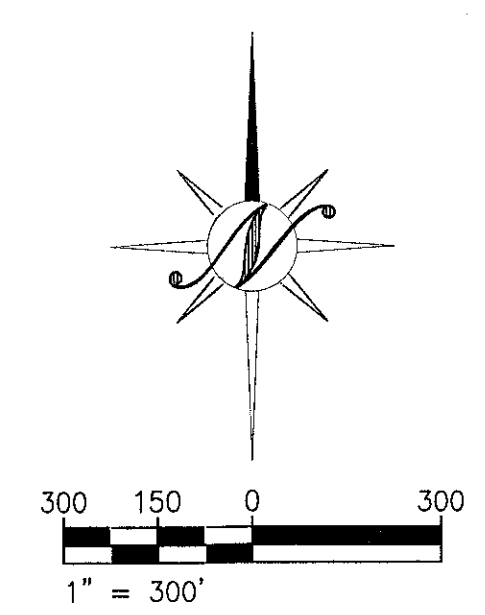
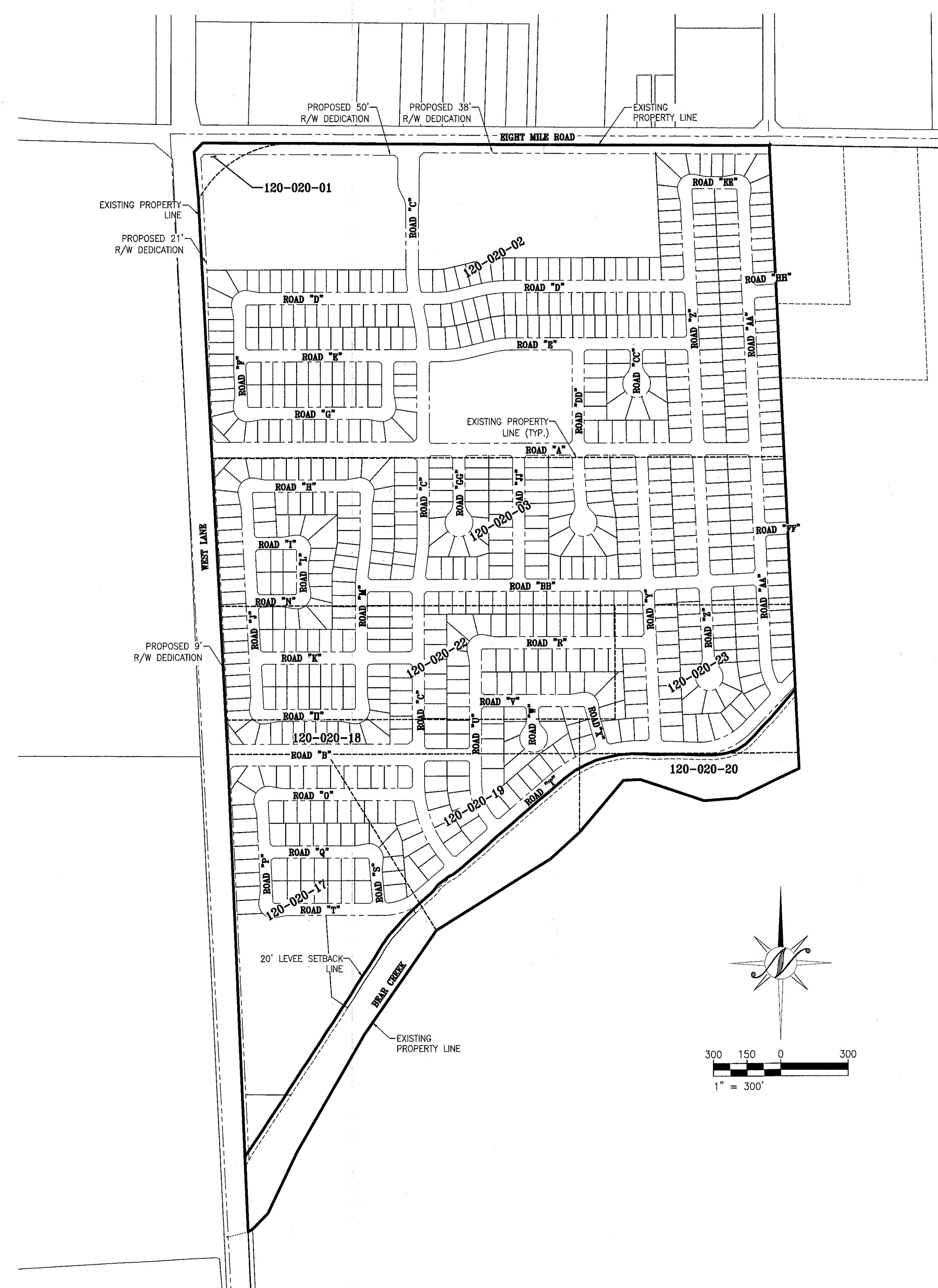

SHEET INDEX

- TM1.1 COVER SHEET
- TM1.2 KEY SHEET AND TYPICAL CROSS-SECTIONS
- TM2.1 TOPOGRAPHY SHEET
- TM2.2 TOPOGRAPHY SHEET
- TM3.1 DIMENSION AND PRELIMINARY GRADING PLAN
- TM3.2 DIMENSION AND PRELIMINARY GRADING PLAN
- TM4.1 PRELIMINARY UTILITY PLAN
- TM4.2 PRELIMINARY UTILITY PLAN
- TM5.1 PRELIMINARY PHASING AND MAJOR OFF-SITE INFRASTRUCTURE
- TM5.2 ALTERNATE PROJECT LAYOUT
- TM5.3 TRAFFIC CALMING PLAN

PROJECT INFORMATION

A. REGULATORY AGENCY:	CITY OF STOCKTON 425 N. EL DORADO STREET STOCKTON, CA 95202 CONTACT: MIKE MC DOWELL
B. OWNER/APPLICANT:	JOHN TOMASELLO 18958 LOUIS ROAD GRASS VALLEY, CA 95945 T: (530) 208-8482
C. ENGINEER:	NORTHSTAR ENGINEERING GROUP, INC 620 12th STREET MODESTO CA, 95354 T: (209) 524-3525 F: (209) 524-3526 CONTACT: TONY DE MELO
D. EXISTING LAND USE/ZONING:	VACANT LOT - ORCHARD/ AU-20
E. PROPOSED LAND USE/ZONING:	RESIDENTIAL, LOW DENSITY - RL
F. TOTAL PROJECT SIZE:	200.16 ACRES (185.5 RESIDENTIAL)
G. TOTAL NUMBER OF LOTS:	747
H. DENSITY:	4.0 UPA
I. CONTOURS:	1' AND ONE HALF' CONTOUR INTERVALS, SURVEYED ON APRIL 1st, 2015.
J. RETURNS:	PER CITY OF STOCKTON STANDARD DETAILS R63 AND R64.

CITY COUNCIL APPROVAL

FILED AS A TENTATIVE MAP THIS 31ST DAY OF JANUARY 2020.
 FEE \$ _____

 COMMUNITY DEVELOPMENT DEPARTMENT
 APPROVED BY THE CITY ENGINEER OF THE CITY OF STOCKTON THIS 10TH DAY OF AUGUST 2020.

 CITY ENGINEER
 APPROVED BY THE STOCKTON CITY COUNCIL BY RESOLUTION NO. 2020-06-23-1502-03 THIS 23RD DAY OF JUNE, 2020.

 SHEET NUMBER
TM 1.1

COVER SHEET
VESTING TENTATIVE SUBDIVISION MAP
TRA VIGNE WEST
STOCKTON, CALIFORNIA

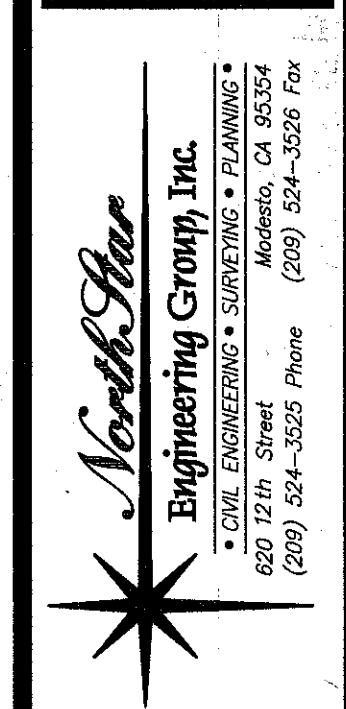

JOB #: 15-1532
 DATE: 06/23/2020
 SCALE: AS SHOWN
 DRAWN: TBA/PMH
 DESIGN: PMH/CV/KM
 CHK'D: TPD
TM 1.1

PLOTTED: 07/20/2021 15:04
 PLOTTER: HP DesignJet T1100e
 FILE: C:\Users\jmc\OneDrive\Documents\TRA Vigne West\TRA Vigne West.dwg

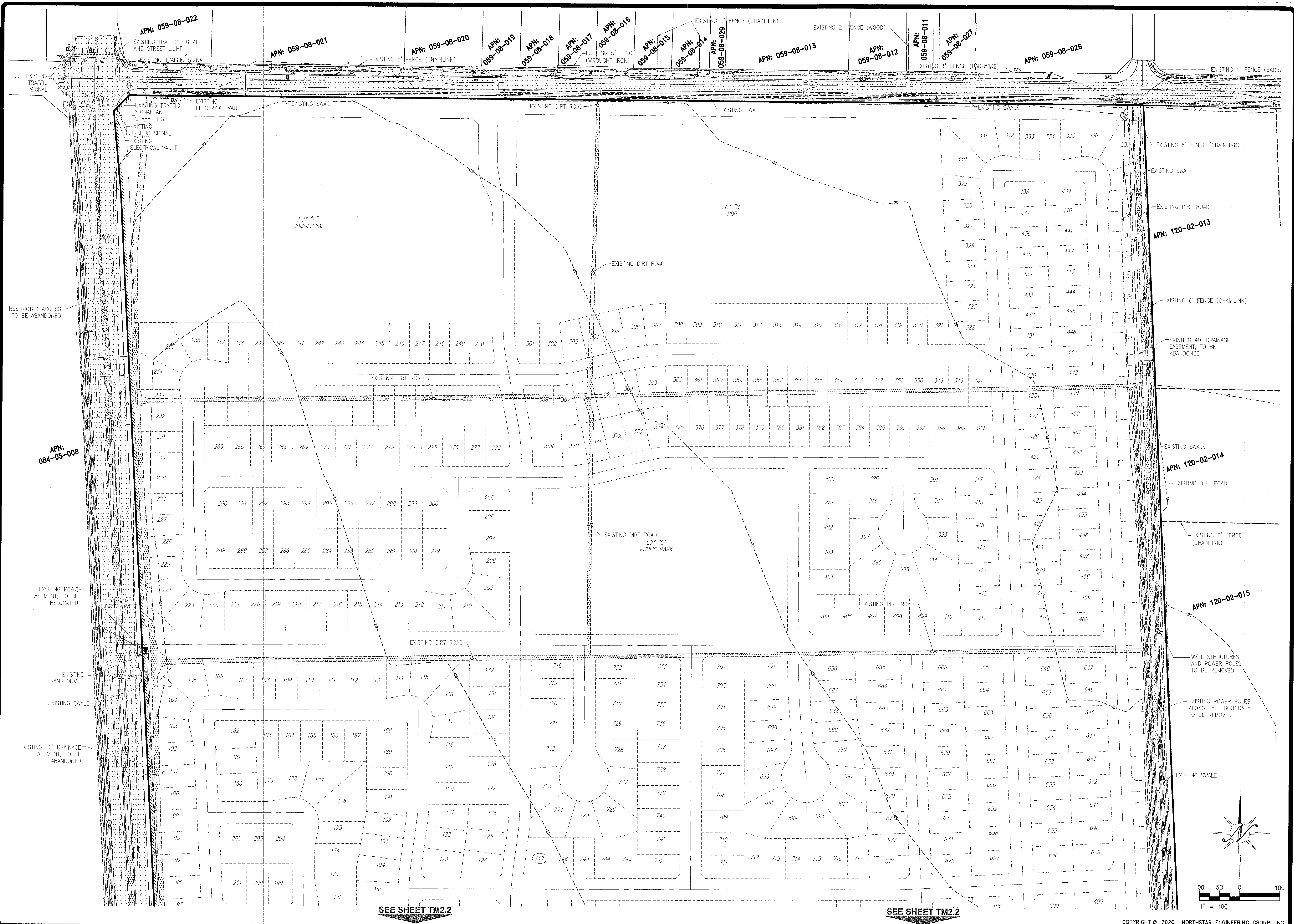

PLOTTED: 01/31/2020 10:25 PLOTTED BY: Phurson
 DYNAMIC: F:\15-1532 Beer Creek East (Powers)\Titleblock Map TM 2.1-TPM.dwg

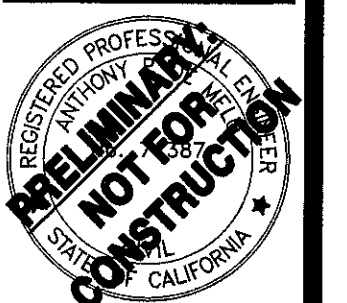

NO.	DATE	APPROVED	REVISIONS	DESCRIPTIONS

STOCKTON, CALIFORNIA

TOPOGRAPHY SHEET
VESTING TENTATIVE SUBDIVISION MAP
TRA VIGNE WEST

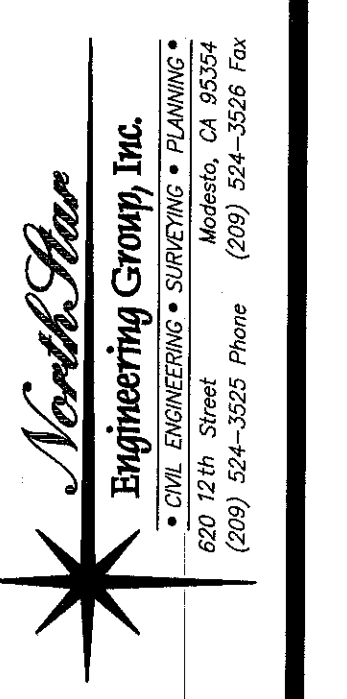

JOB #:	15-1532
DATE:	01/31/2020
SCALE:	AS SHOWN
DRAWN:	TRV/TMB
DESIGN:	PMH/CV/KM
CHK'D:	TPD

SHEET NUMBER
TM 2.1

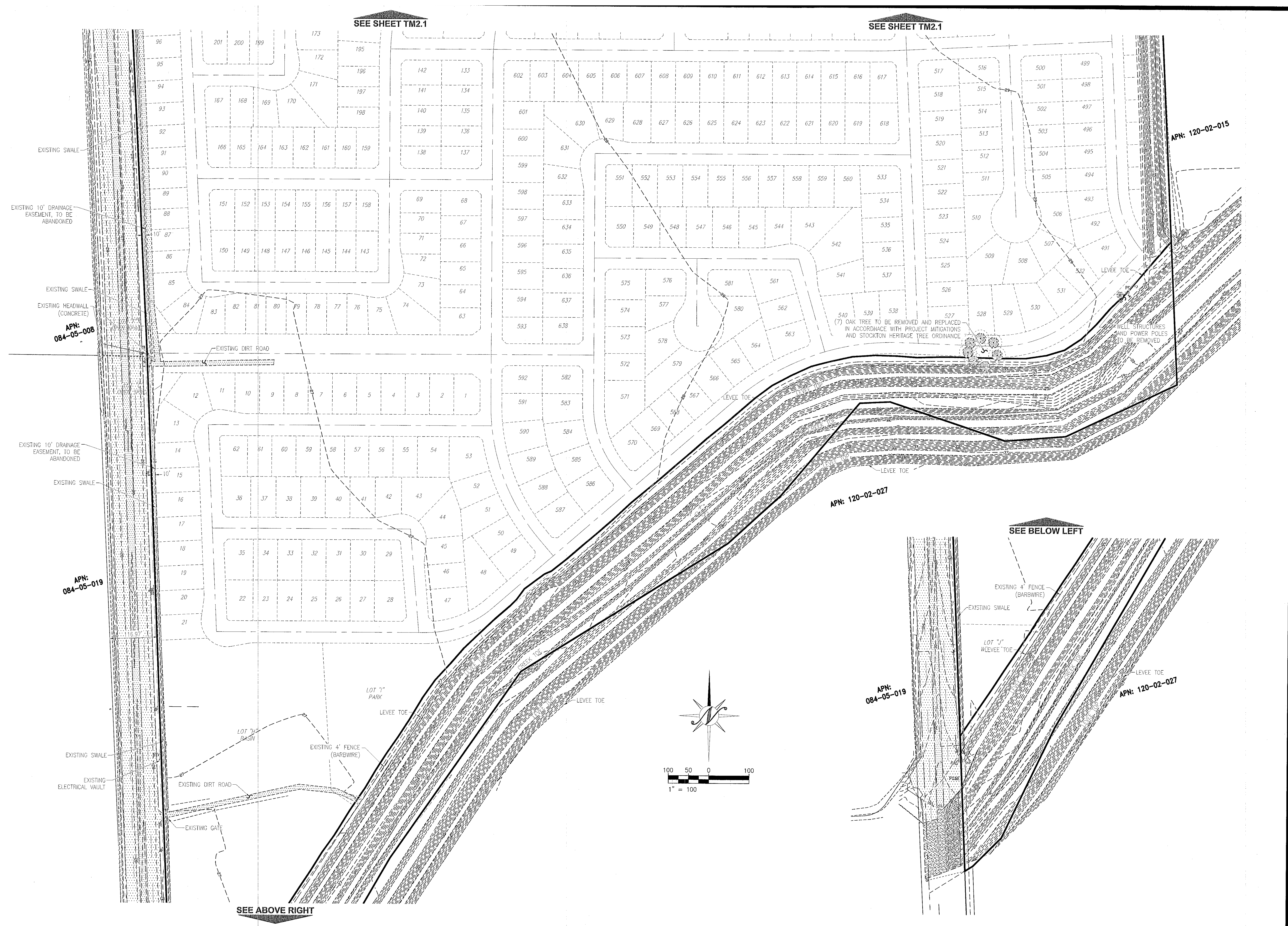

PLOTTED: 01/31/2020 10:55 PLOTTED BY: PCH/CH
 DRAWING FILE: H22 Item: Creek (left) (Powers) (Topographic Map) (TM 2.2-TPM.dwg)

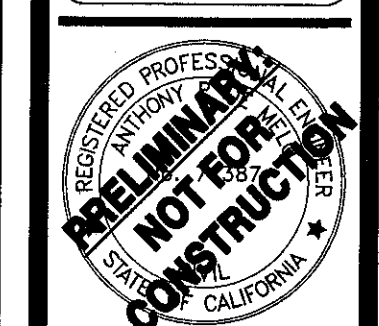

NO.	DATE	APPROVED	REVISIONS	DESCRIPTIONS

TOPOGRAPHY SHEET
VESTING TENTATIVE SUBDIVISION MAP
TRA VIGNE WEST
STOCKTON, CALIFORNIA

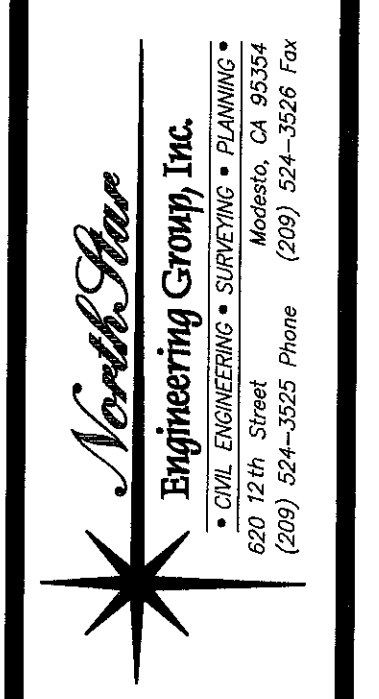

JOB #: 15-1532
 DATE: 01/31/2020
 SCALE: AS SHOWN
 DRAWN: TBA/PMH
 DESIGN: PMH/CV/KM
 CHK'D: JPD

SHEET NUMBER
TM 2.2



REVISIONS

DATE

APPROVED

DESCRIPTIONS

NO.

DIMENSION AND PRELIMINARY GRADING PLAN

VESTING TENTATIVE SUBDIVISION MAP

TRA VIGNE WEST

STOCKTON, CALIFORNIA

JOB # 15-1532

DATE 01/31/2020

SCALE: AS SHOWN

DRAWN: TBA/PM

DESIGN: PMH/CV/KM

CHK'D: JPD

SHEET NUMBER

TM 3.1

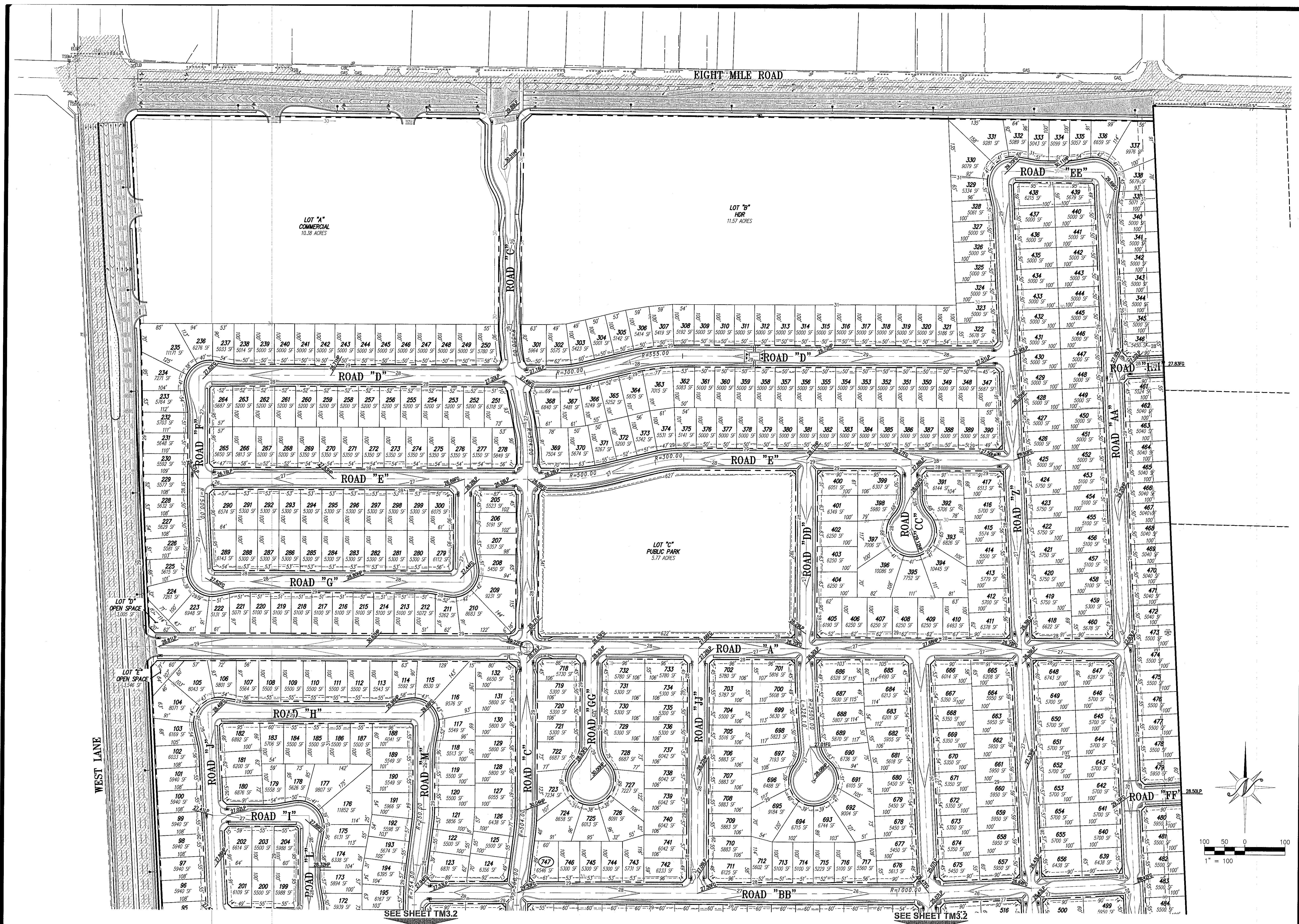



NO.	DATE	APPROVED	REVISIONS	DESCRIPTIONS

PRELIMINARY UTILITY PLAN
VESTING TENTATIVE SUBDIVISION MAP
TRA VIGNE WEST
CALIFORNIA

STOCKTON, CALIFORNIA

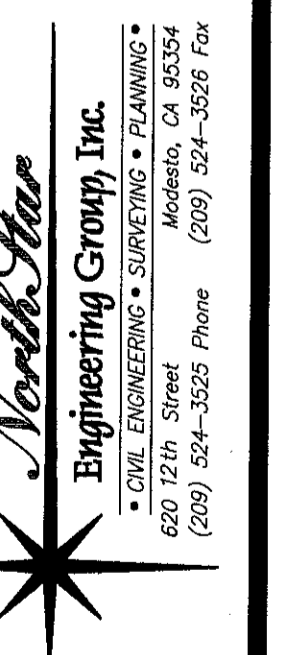

JOB #: 15-1532
DATE: 01/31/2020
SCALE: AS SHOWN
DRAWN: TBA/PMH
DESIGN: PMH/CV/KM
CHK'D: TPD

SHEET NUMBER

TM 4.2

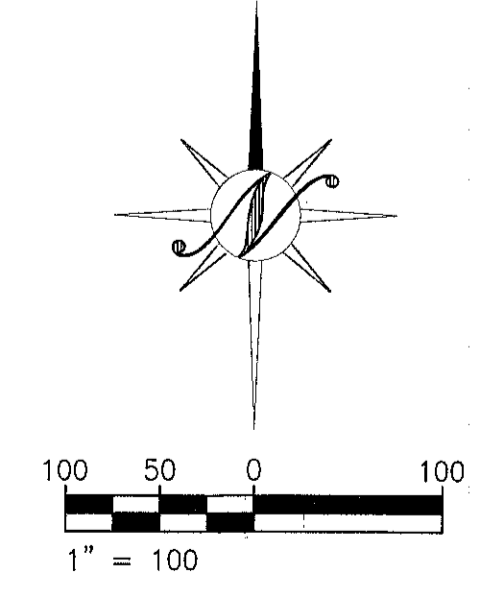
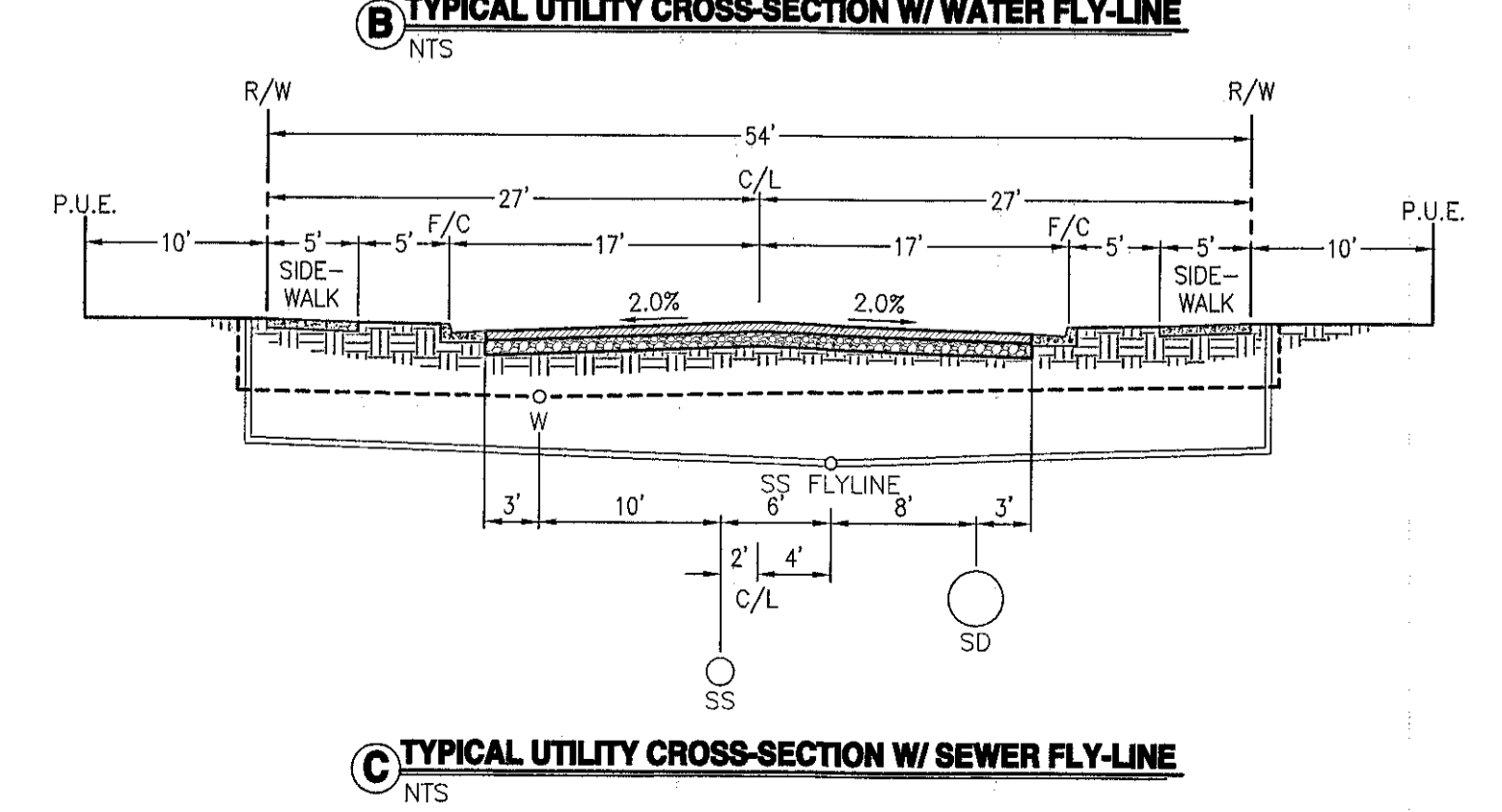
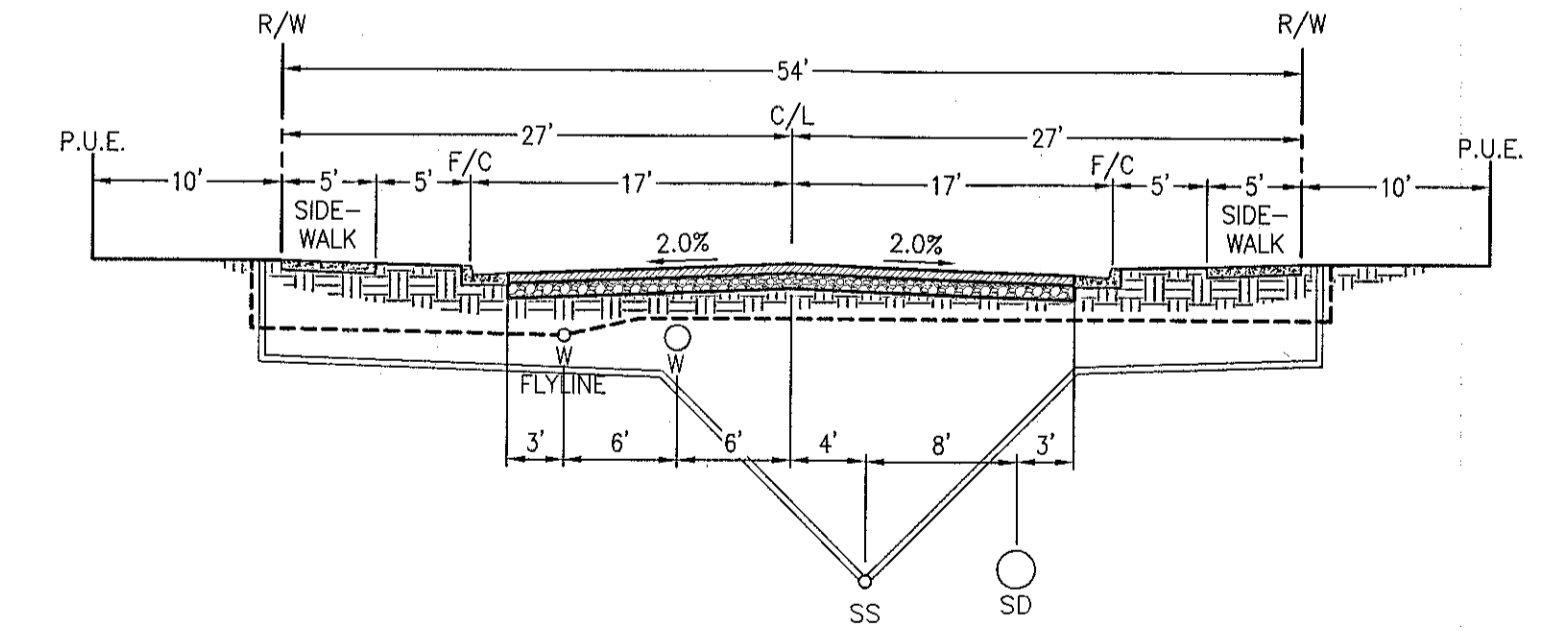
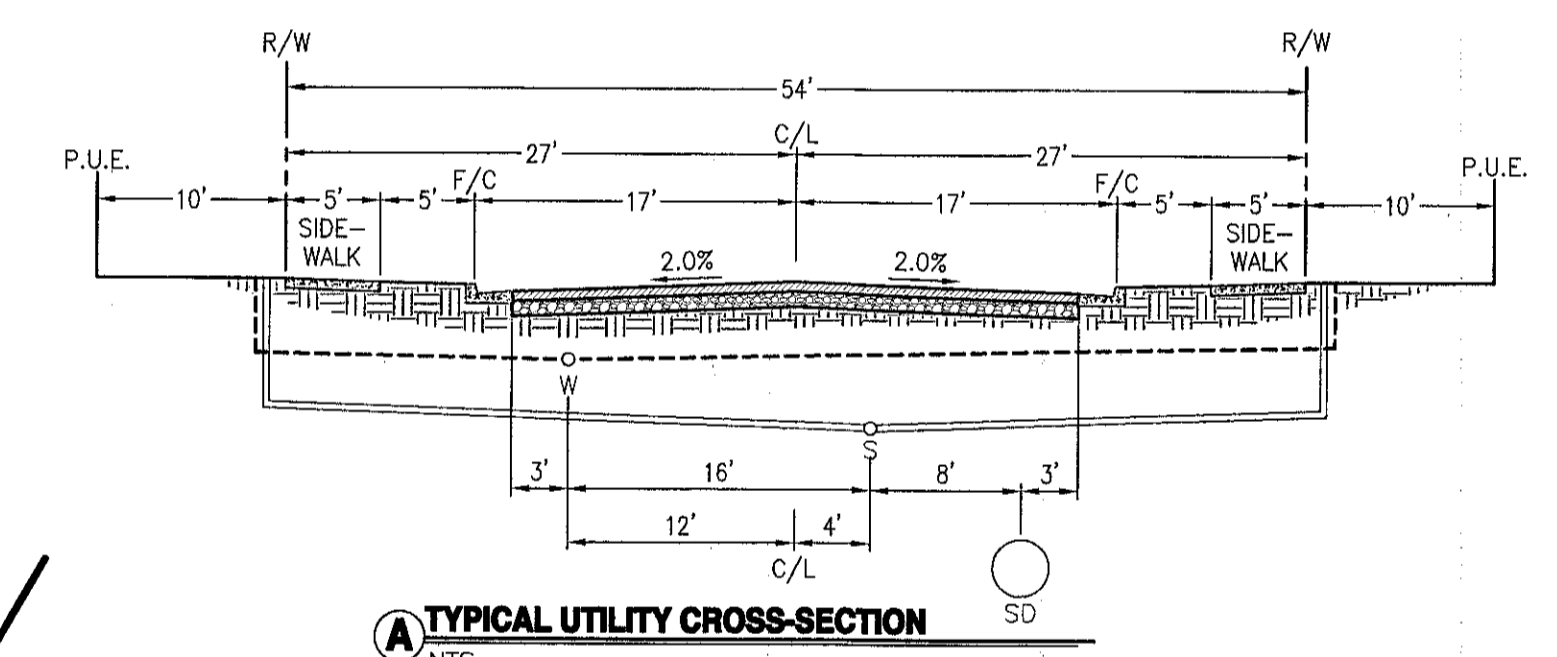
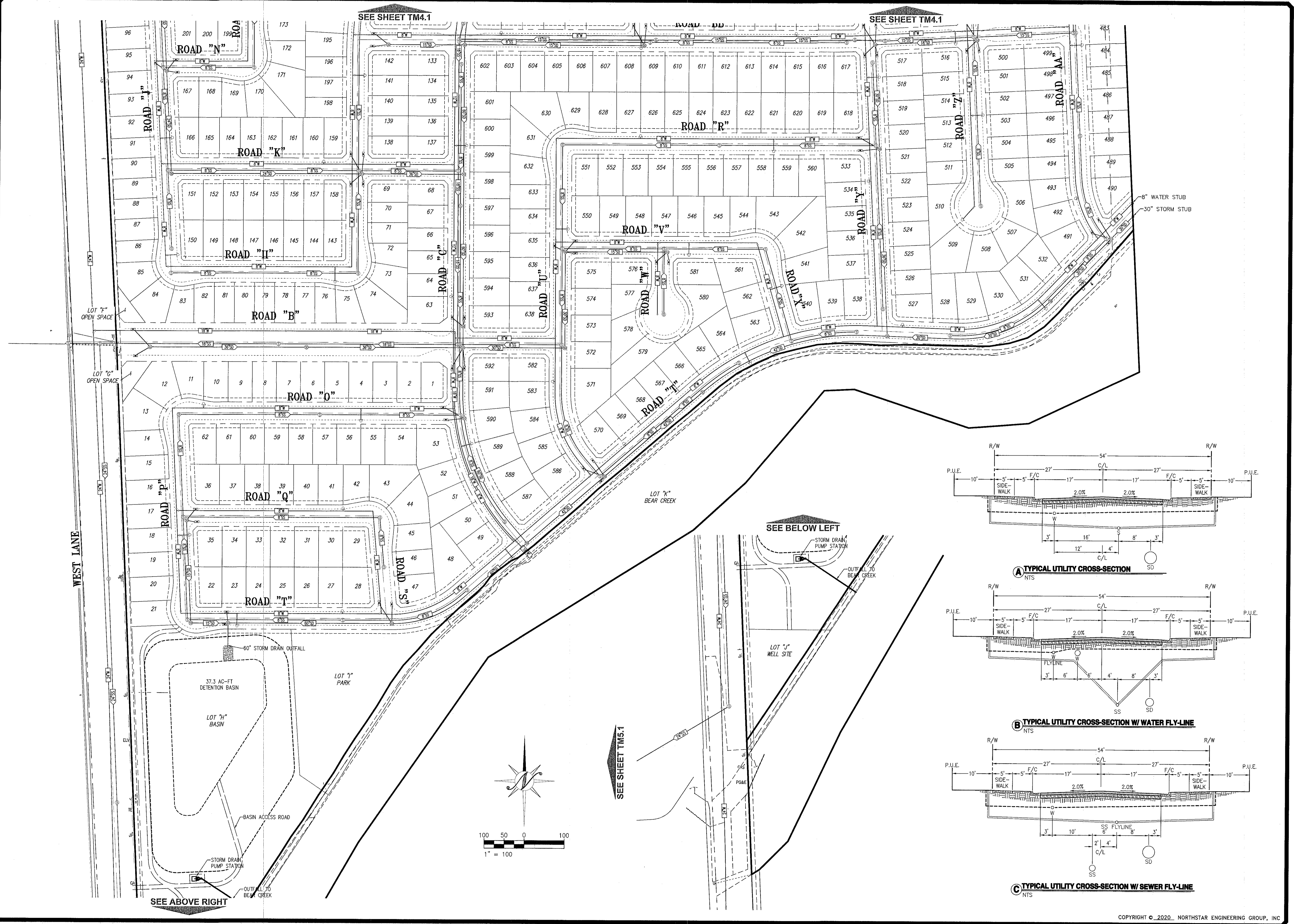

PLOTTED: 01/29/2020 10:29 AM
 PLOTTER: HP DesignJet T830
 DRAWING: E:\15-1532 Bear Creek East\Drawings\Utilities\TM 4.2-UT.dwg

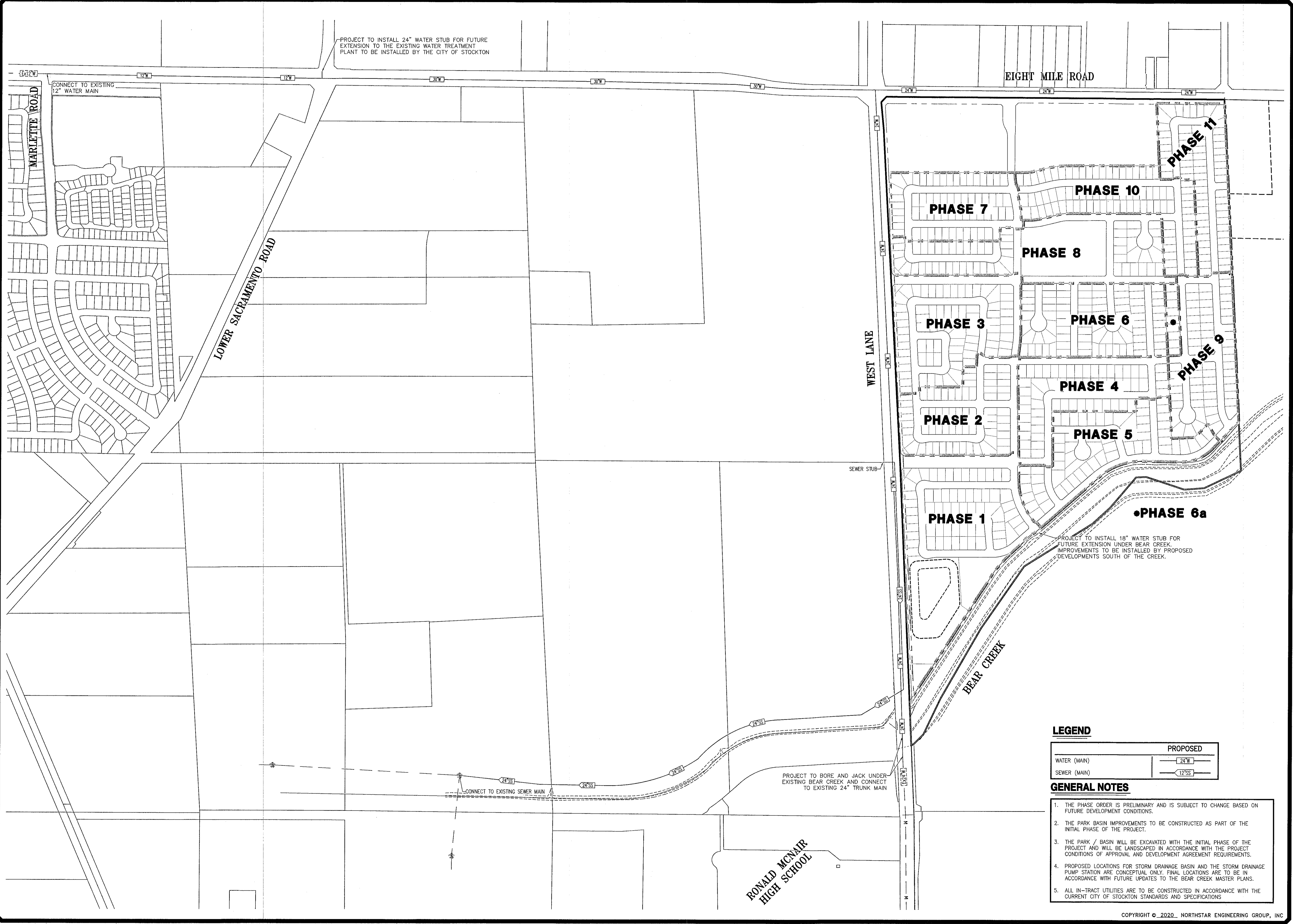

PROJECT TO INSTALL 24" WATER STUB FOR FUTURE EXTENSION TO THE EXISTING WATER TREATMENT PLANT TO BE INSTALLED BY THE CITY OF STOCKTON

CONNECT TO EXISTING 12" WATER MAIN

SEWER STUB

PROJECT TO INSTALL 18" WATER STUB FOR FUTURE EXTENSION UNDER BEAR CREEK. IMPROVEMENTS TO BE INSTALLED BY PROPOSED DEVELOPMENTS SOUTH OF THE CREEK.

PROJECT TO BORE AND JACK UNDER EXISTING BEAR CREEK AND CONNECT TO EXISTING 24" TRUNK MAIN

CONNECT TO EXISTING SEWER MAIN

LEGEND

PROPOSED	
WATER (MAIN)	24" W
SEWER (MAIN)	12" SS

GENERAL NOTES

1. THE PHASE ORDER IS PRELIMINARY AND IS SUBJECT TO CHANGE BASED ON FUTURE DEVELOPMENT CONDITIONS.
2. THE PARK BASIN IMPROVEMENTS TO BE CONSTRUCTED AS PART OF THE INITIAL PHASE OF THE PROJECT.
3. THE PARK / BASIN WILL BE EXCAVATED WITH THE INITIAL PHASE OF THE PROJECT AND WILL BE LANDSCAPED IN ACCORDANCE WITH THE PROJECT CONDITIONS OF APPROVAL AND DEVELOPMENT AGREEMENT REQUIREMENTS.
4. PROPOSED LOCATIONS FOR STORM DRAINAGE BASIN AND THE STORM DRAINAGE PUMP STATION ARE CONCEPTUAL ONLY. FINAL LOCATIONS ARE TO BE IN ACCORDANCE WITH FUTURE UPDATES TO THE BEAR CREEK MASTER PLANS.
5. ALL IN-TRACT UTILITIES ARE TO BE CONSTRUCTED IN ACCORDANCE WITH THE CURRENT CITY OF STOCKTON STANDARDS AND SPECIFICATIONS



NO.	REVISIONS	DATE	APPROVED

PRELIMINARY PHASING AND MAJOR OFF-SITE INFRASTRUCTURE
VESTING TENTATIVE SUBDIVISION MAP
TRA VIGNE WEST
 STOCKTON, CALIFORNIA

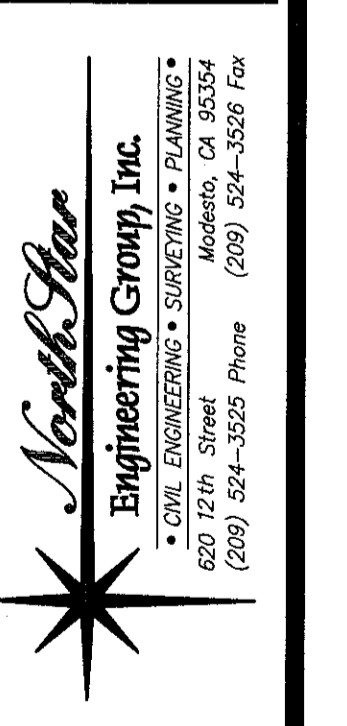

JOB #:	15-1532
DATE:	01/31/2020
SCALE:	AS SHOWN
DRAWN:	TEB/CMH
DESIGN:	PMV/CV/KM
CHK'D:	TPD

SHEET NUMBER
TM 5.1

PLOTTED: 01/31/2020 10:30
 PLOTTED BY: Pheobon
 COMMAND: F:\15-1532_Bear Creek East\Parsons\Utilities_Maps\TM 5.1-Phase.dwg

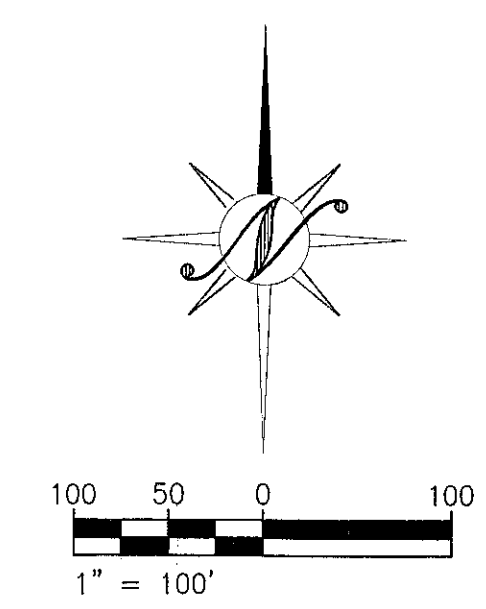
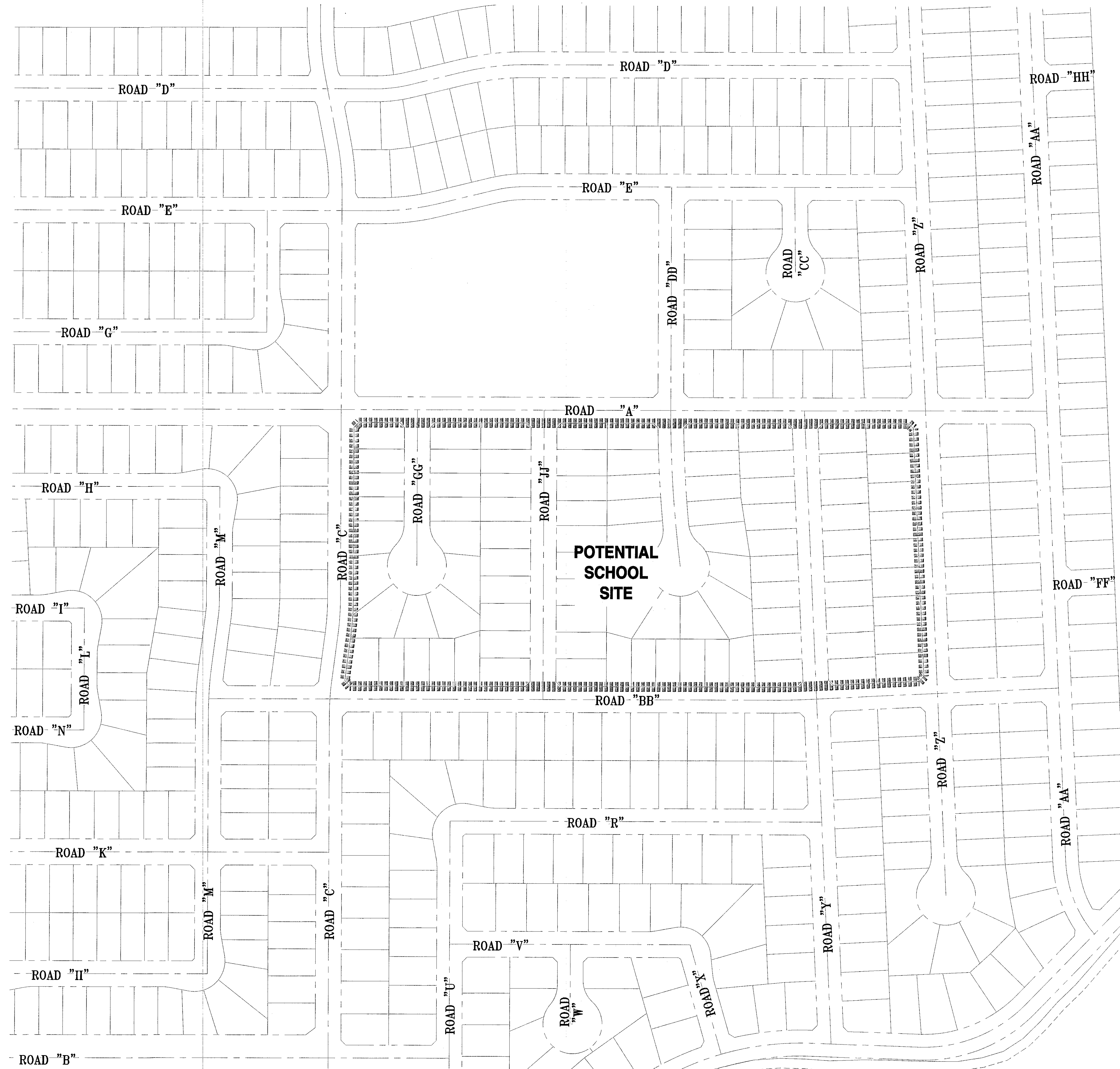

NOTE
 PROPOSED LIMIT OF POSSIBLE VESTING TENTATIVE MAP REVISIONS TO ACCOUNT FOR PROPOSED SCHOOL SITE. THE SCHOOL DISTRICT IS TO DETERMINE THAT THIS SITE IS TO BE UTILIZED. A TOTAL OF 91 RESIDENTIAL UNITS TO BE REMOVED TO ACCOUT FOR THE SCHOOL SITE.

DATE: 01/31/2020 15:32 PLOTTED BY: P:\Projects\15-1532\15-1532.dwg
 PLOT DATE: 01/31/2020 15:32 PLOTTED BY: P:\Projects\15-1532\15-1532.dwg



NO.	DATE	APPROVED	REVISIONS	DESCRIPTIONS

ALTERNATE PROJECT LAYOUT
VESTING TENTATIVE SUBDIVISION MAP
TRA VIGNE WEST
STOCKTON, CALIFORNIA

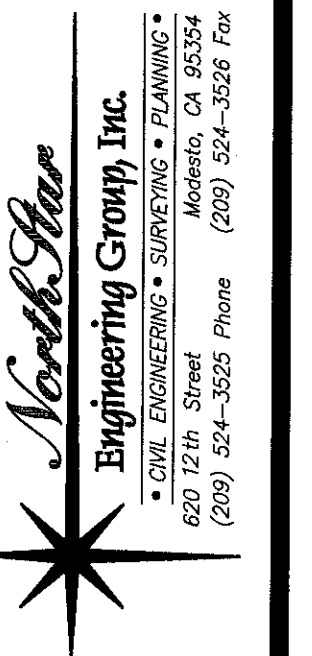

JOB #: 15-1532
 DATE: 01/31/2020
 SCALE: AS SHOWN
 DRAWN: PBA/PMT
 DESIGN: PMH/CV/KM
 CHK'D: TPD

SHEET NUMBER
TM 5.2

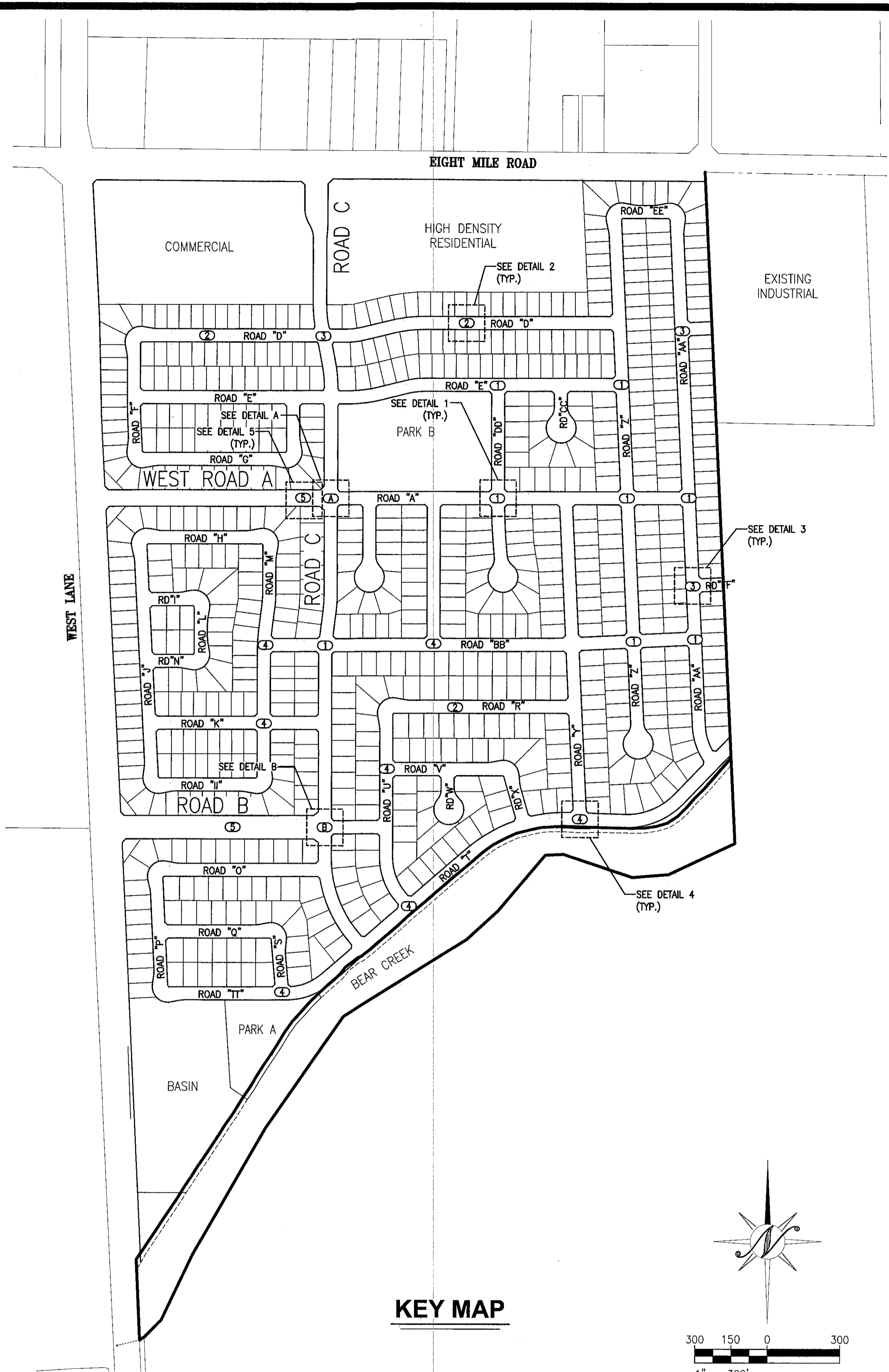

KEY MAP

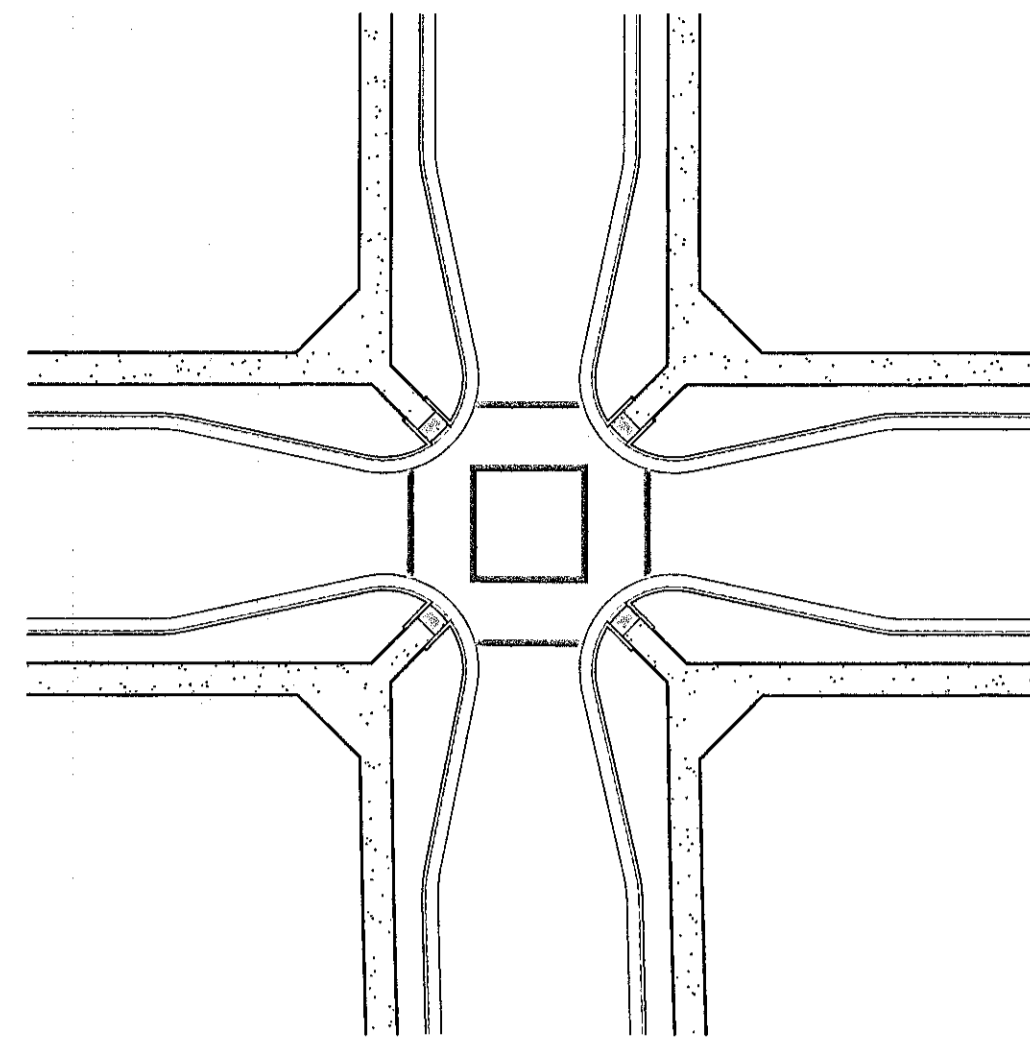
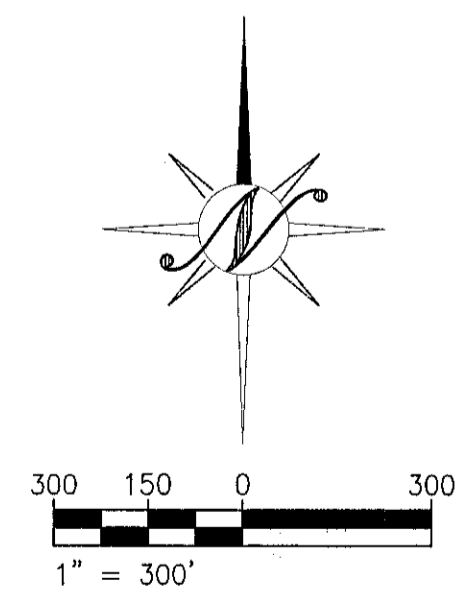

TYPICAL INTERSECTION WITH BULB OUTS

1 PER CITY STANDARD DETAIL R-18
NTS

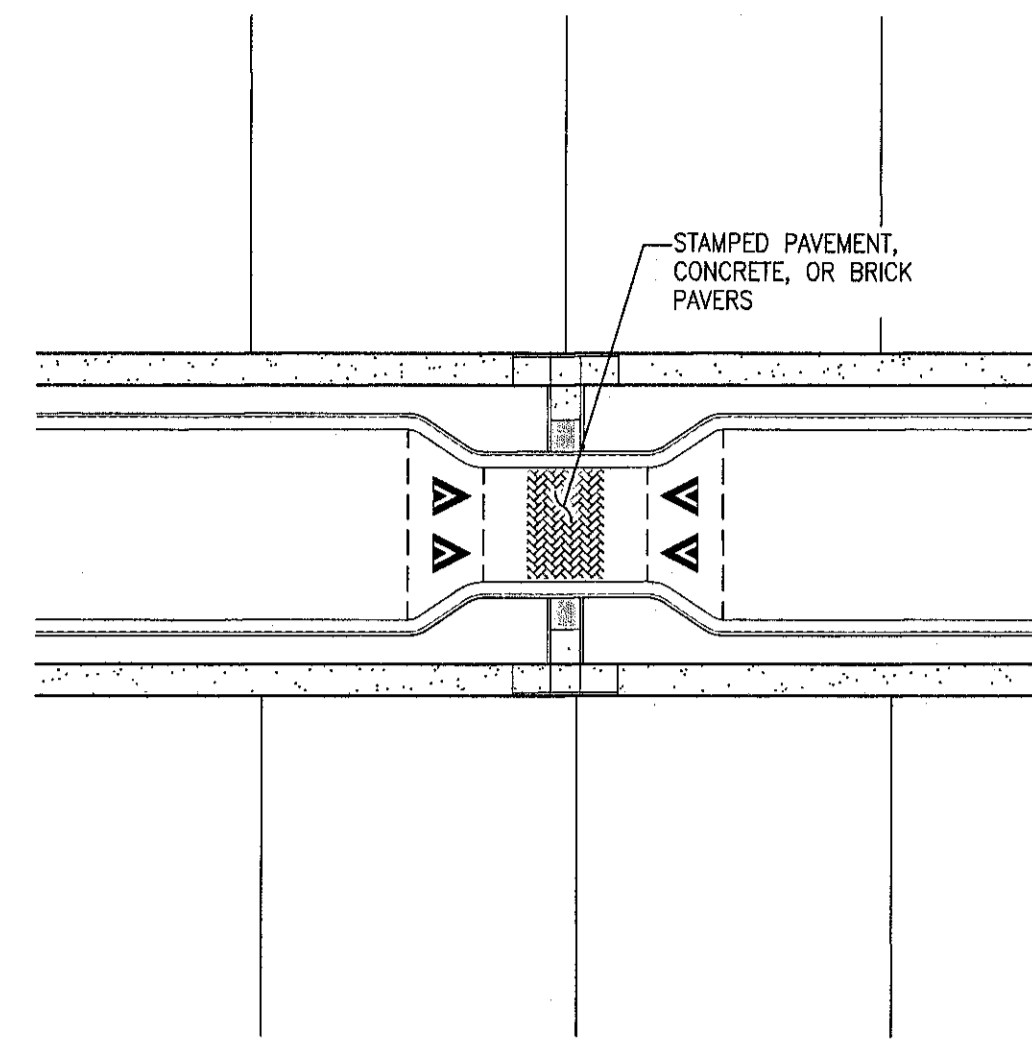

INTERSECTION WITH RAISED CROSSWALK

2 NTS

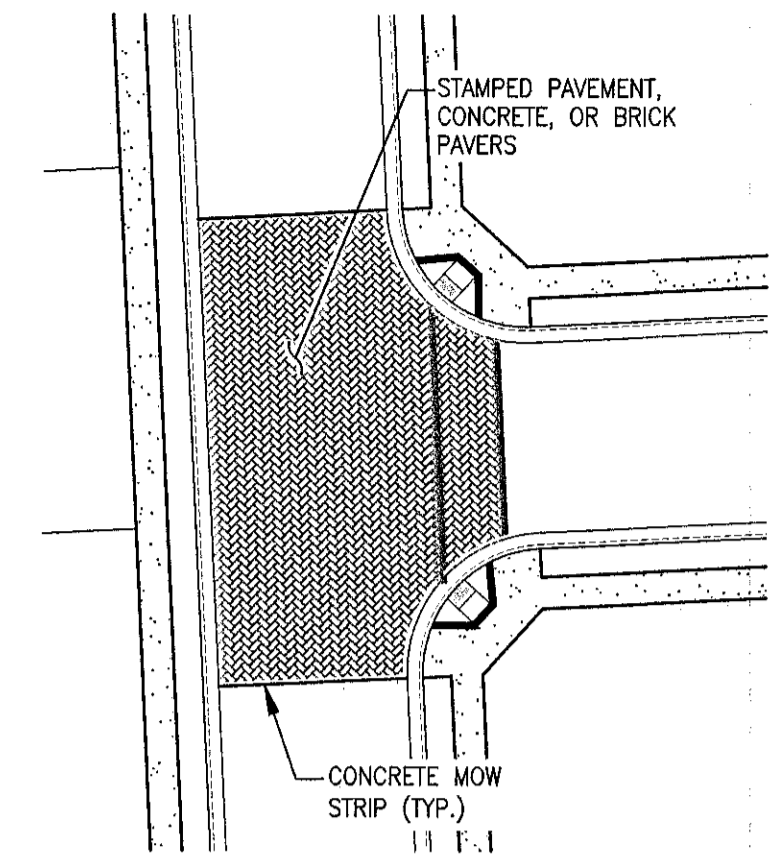

INTERSECTION WITH TEXTURED PAVEMENT

3 NTS

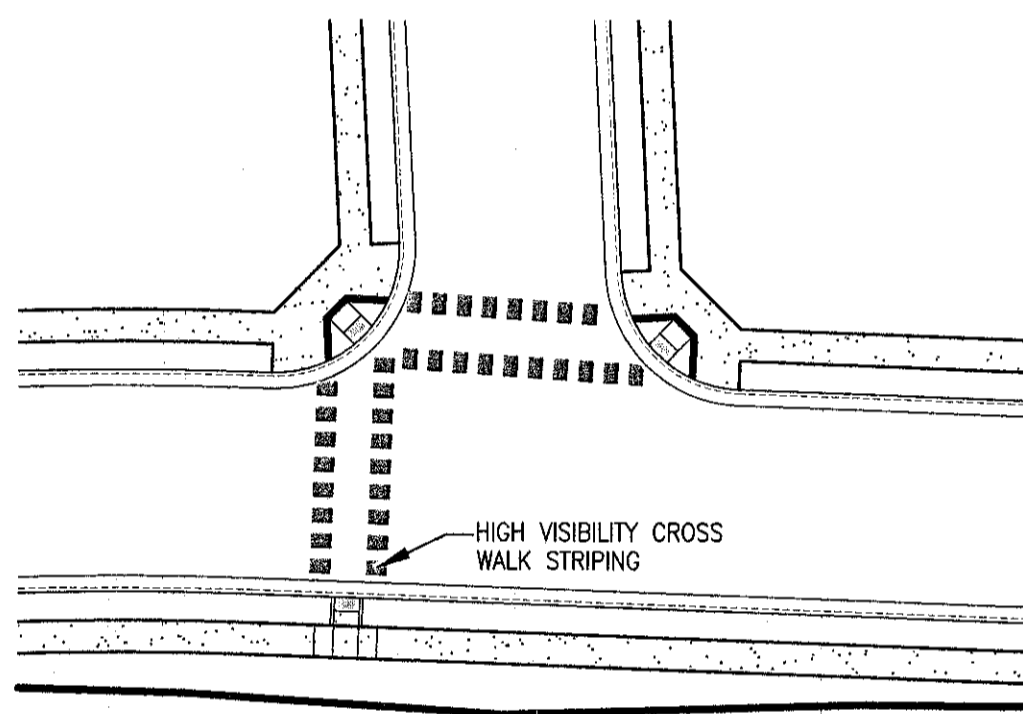

INTERSECTION WITH HIGH VISIBILITY CROSSWALK

4 NTS

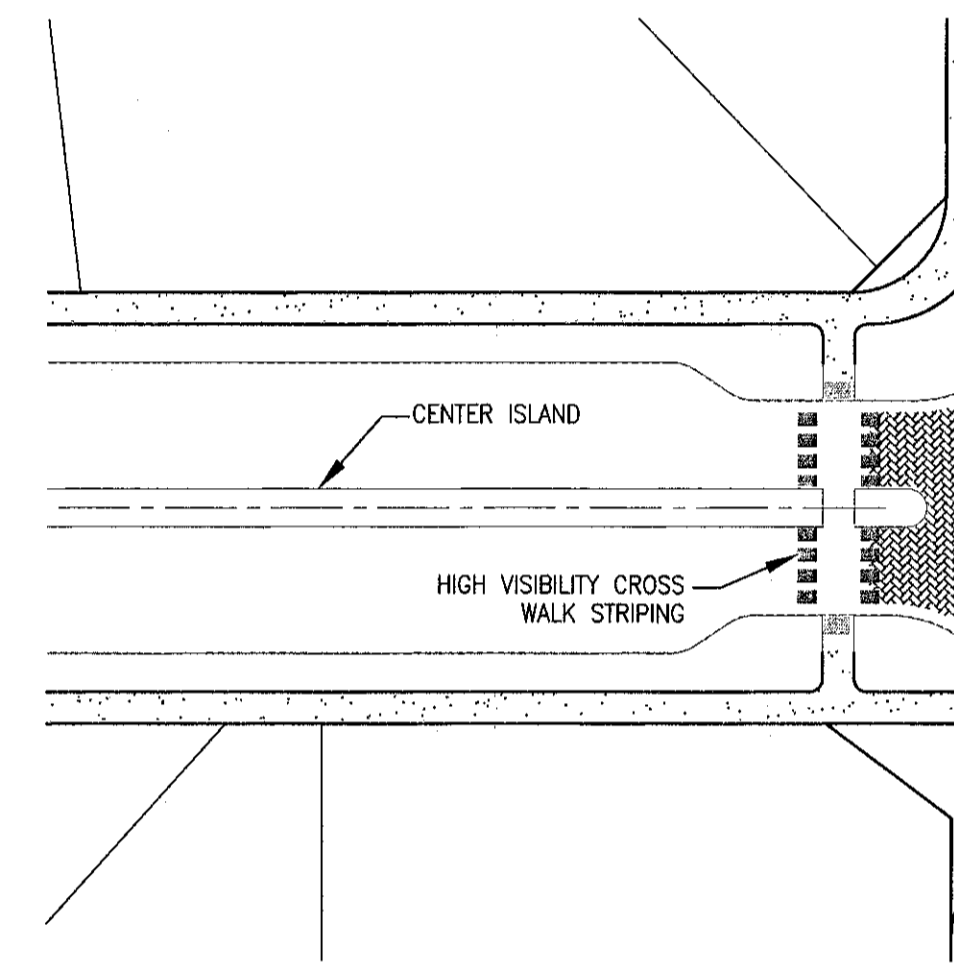

CENTER ISLAND NARROWING

5 NTS

NOTE: ADDITIONAL STOP AND YIELD SIGNS TO BE INSTALLED AT THE DIRECTION OF THE CITY OF STOCKTON.

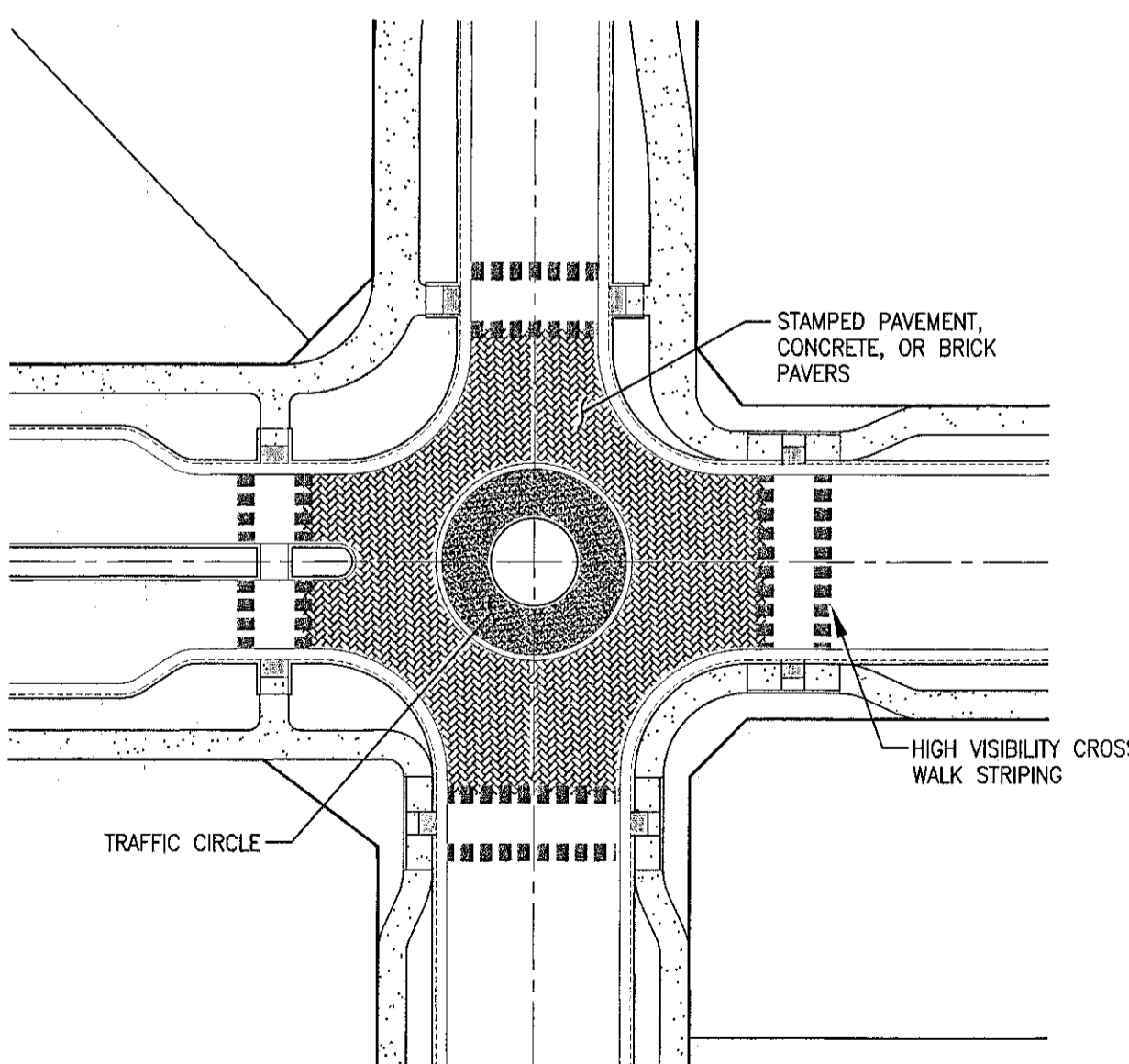

INTERSECTION AT ROADS A AND C

A NTS

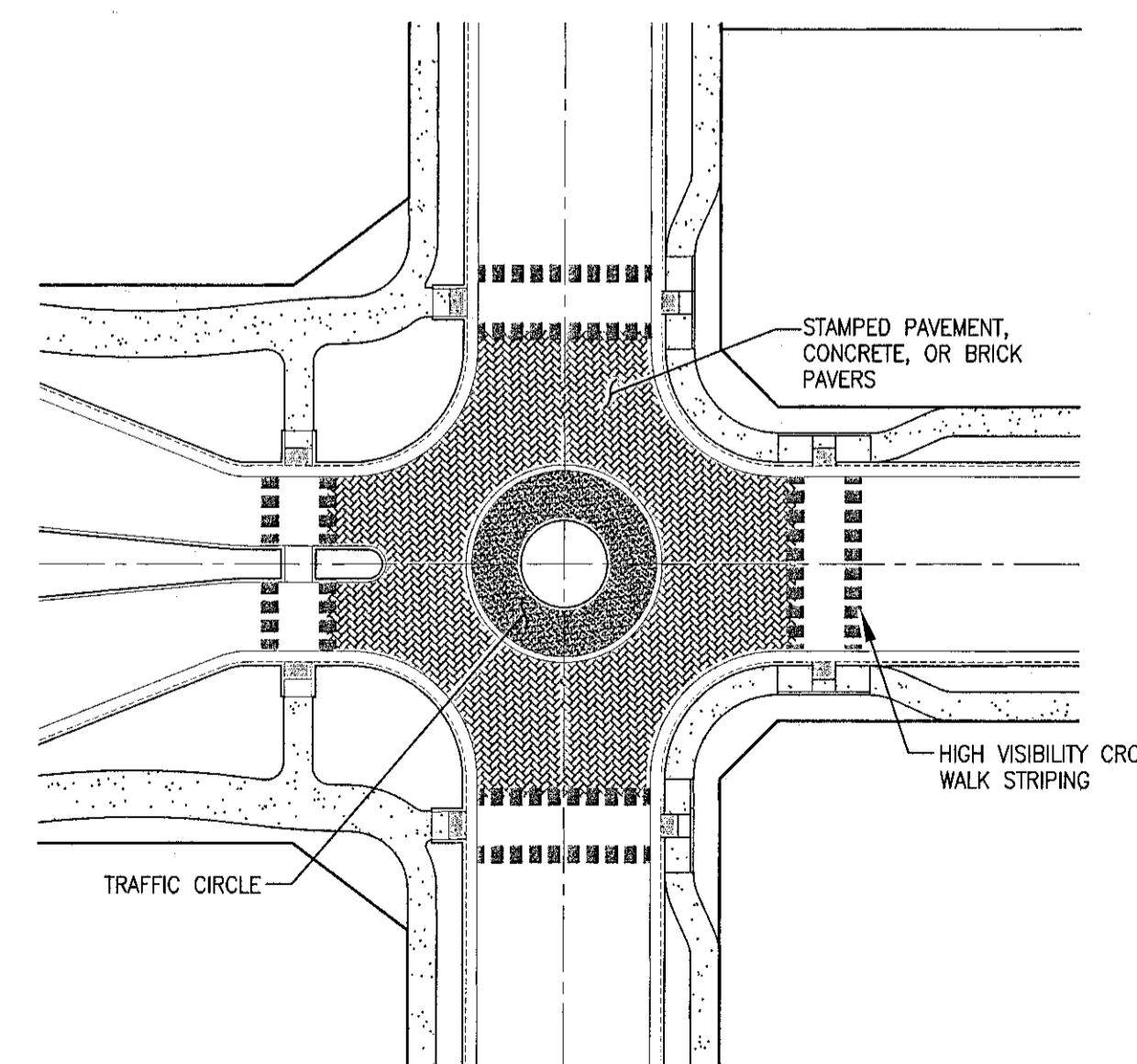

INTERSECTION AT ROADS B AND C

B NTS

KEY NOTES

- 1 PROPOSED LIMIT OF POSSIBLE VESTING TENTATIVE MAP REVISIONS TO ACCOUNT FOR PROPOSED SCHOOL SITE. THE SCHOOL DISTRICT IS TO DETERMINE THAT THIS SITE IS TO BE UTILIZED. A TOTAL OF 91 RESIDENTIAL UNITS TO BE REMOVED TO ACCOMMODATE THE SCHOOL SITE.
- 2 PROPOSED LIMIT OF POSSIBLE VESTING TENTATIVE MAP REVISION TO ALLOW FOR PROPOSED BEAR CREEK BRIDGE CROSSING. IF IT IS DETERMINED DURING THE PREPARATION OF THE EIR OR PROCESSING OF THE TRAFFIC STUDY THAT A BRIDGE IS REQUIRED, THEN THE TENTATIVE MAP SHALL BE REVISED ACCORDINGLY TO LOOSE & LOTS.



NO.	REVISIONS	DATE	APPROVED

TRAFFIC CALMING PLAN
VESTING TENTATIVE SUBDIVISION MAP
TRA VIGNE WEST
 STOCKTON, CALIFORNIA

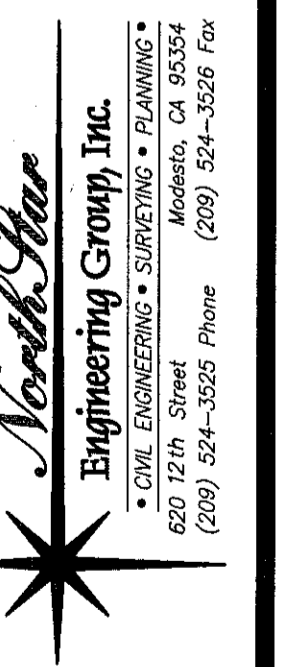

JOB #: 15-1532
 DATE: 07/31/2020
 SCALE: AS SHOWN
 DRAWN: TBA/PMH
 DESIGN: PMH/CV/KM
 CHK'D: TPD

SHEET NUMBER

TM 5.3

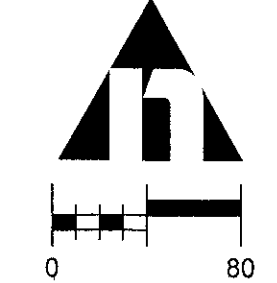
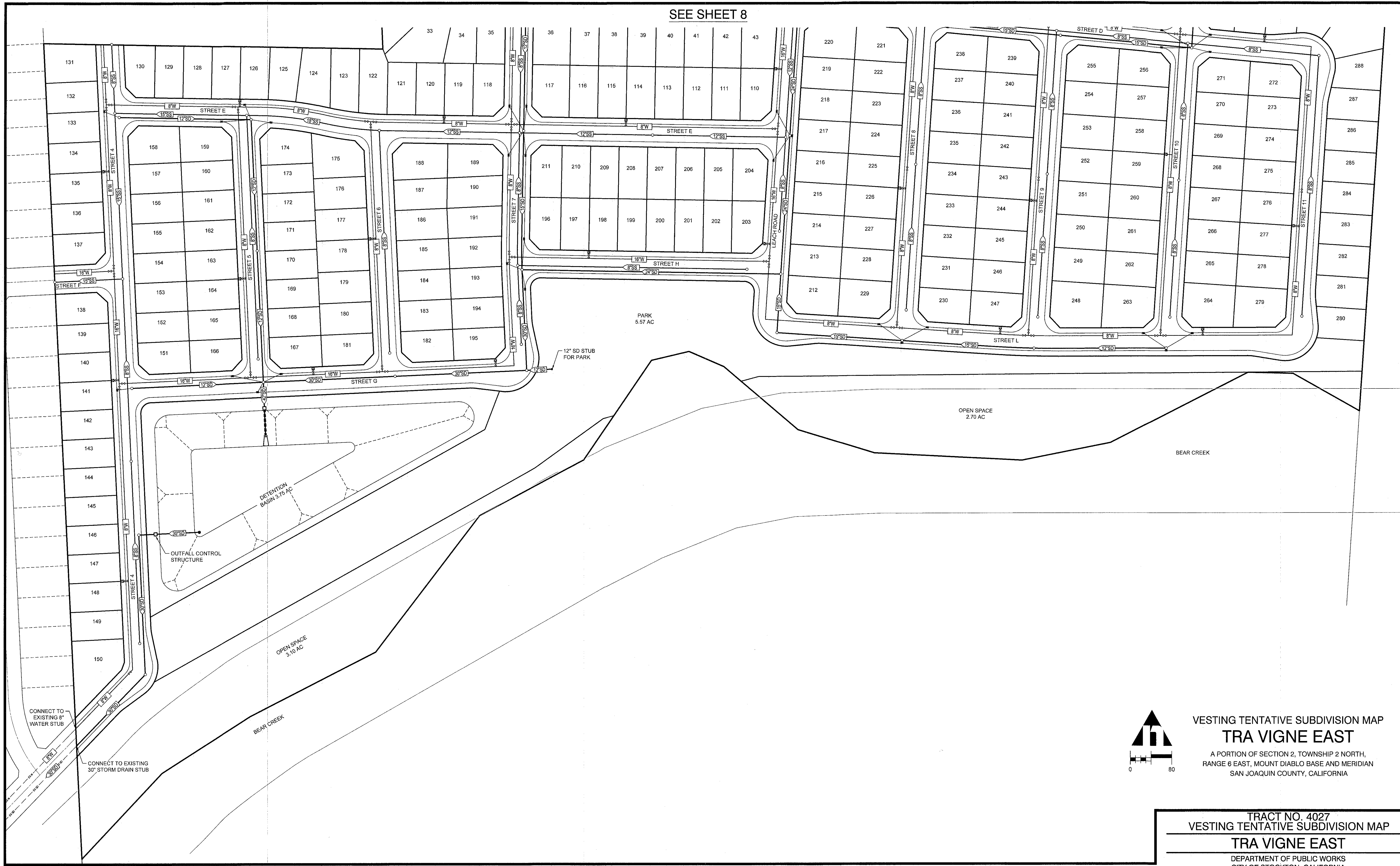

VESTING TENTATIVE SUBDIVISION MAP
TRA VIGNE EAST
 A PORTION OF SECTION 2, TOWNSHIP 2 NORTH,
 RANGE 6 EAST, MOUNT DIABLO BASE AND MERIDIAN
 SAN JOAQUIN COUNTY, CALIFORNIA

TRACT NO. 4027
 VESTING TENTATIVE SUBDIVISION MAP
TRA VIGNE EAST
 DEPARTMENT OF PUBLIC WORKS
 CITY OF STOCKTON, CALIFORNIA



UTILITY PLAN - SOUTH

REVISIONS				
NO.	DESCRIPTIONS	DATE	BY	APPROVED BY

MCR ENGINEERING
 www.mcreng.com

MCR ENGINEERING, INC.
 1242 DUPONT COURT
 MANTECA, CA 95336
 TEL : (209) 239 - 6229
 FAX : (209) 239 - 8839



JOB NO. 16-016	APPROVED BY:	SHEET NO.
DATE FEBRUARY, 2020	_____	10
SCALE AS SHOWN		OF 10 SHEETS
DR. BY MS		PROJECT NO.
CK. BY RM		
FILE _____	CITY ENGINEER STOCKTON, CALIFORNIA	